

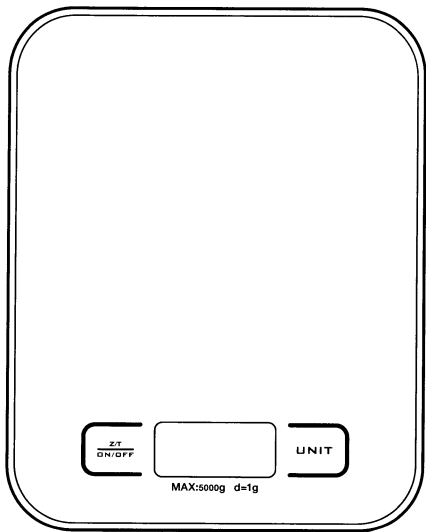

## Digital Kitchen Scale

Model No. EK6015



### Questions or Concerns?

Please contact us: (855) 686-3835  
support@etekcity.com

## Thank You.

Thank you for purchasing the Digital Kitchen Scale (EK6015) by Etekcity. Easily measure your garnishes and ingredients by grams, milliliters, pounds and ounces with the quick unit conversion button. The digital scale features a handy auto-tare function so you can easily measure ingredients in a dish without having to do any math, so you can cut down on prep time to enjoy your meal. The scale is designed with a smooth stainless steel platform for easy cleaning and maintenance.

We're constantly working at building better living with the products and services we create. Should you ever experience any issues with your new product, feel free to contact our helpful customer service team toll-free at (855) 686-3835 or by e-mail at [support@etekcity.com](mailto:support@etekcity.com).



# Table of Contents

Safety Information	1
Main Functions	2
Set-Up	3
Operation	4
Specifications	8
Troubleshooting	9
Customer Support	10
Warranty Information	11



## Safety Information

**IMPORTANT:** Please read and comply with all of the instructions and warnings provided in this manual before using the product. Failure to comply with the instructions and warnings provided herein may result in inaccurate results and/or damage to the product itself.

### Important Safety Information

- Always place the scale on a hard, dry and flat surface before measurement in order to ensure accuracy.
- **DO NOT** exceed the 5,000g weight capacity. An overload indicator will appear on the LCD display if the limit is exceeded.
- **DO NOT** immerse the scale in water or corrosive liquids. If a liquid is spilled on the scale platform, immediately wipe the scale clean with a soft cloth in order to avoid potential damage to the scale.
- When replacing batteries, make sure to insert them under the correct polarity as indicated within the battery compartment.
- Replace the batteries if the low-battery indicator is displayed in order to ensure the highest accuracy.
- **DO NOT** mix new and used batteries to power the device.
- This scale is not intended for commercial or heavy-duty use.
- When not in use, store the scale in a cool, dry environment.
- To clean, wipe the platform surface with a damp soft cloth.
- If the scale fails to turn on, check whether the batteries are installed correctly. Replace the batteries if necessary.
- If the scale is not in use for an extended period of time, take out the batteries to extend the scale service lifetime.



## Main Functions

### Function Diagram

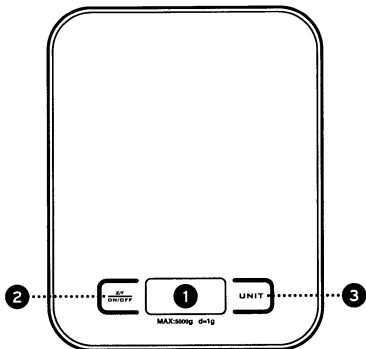

1. LCD Display
2. Power / Auto-Tare
3. Unit Selection

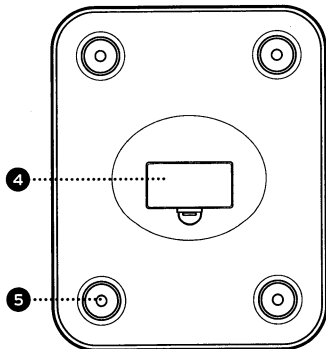

4. Battery Compartment
5. Anti-Skid Padding



## Set-Up

The included AAA batteries are preinstalled in the scale. Open the battery compartment cover located on the backside of the scale.

Remove the plastic strip from the battery compartment to allow the batteries to power the device. Reapply the battery compartment cover.

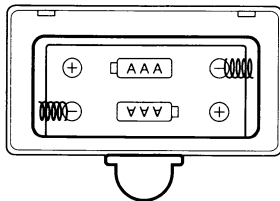
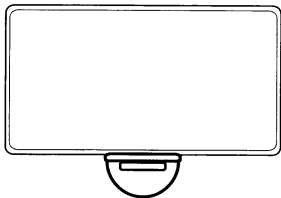



## Operation

### Normal Weighing Mode

1. Place the scale on a flat and level hard surface for measurement.
2. Press the 'ON/OFF' button to turn on the scale. Wait until the screen displays zero before measuring.
3. Place the object of measurement on the center of the weighing platform.
4. Allow the scale to adjust to the weight of the object for a few seconds before it displays the final measured reading on the LCD screen.

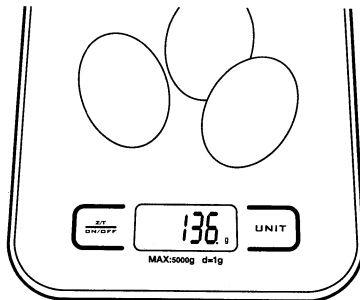
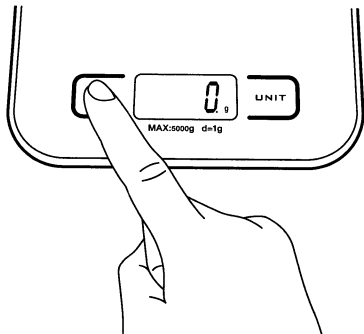

## Zero / Tare Function

The tare function allows the user to deduct the weight of a container from the total weight in order to determine the net weight of the contents excluding the weight of the container which holds them.

1. Turn on the scale and wait for the screen to display zero. If the screen does not display zero automatically, press the 'Z/T' button to auto-adjust to zero.

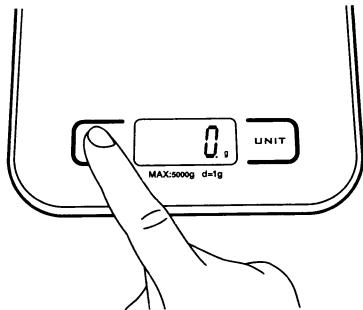

2. Place the desired object which is to be excluded, on the center of the measuring platform.
3. Press the 'Z/T' button to tare the current weight of the object. The screen should now display zero.

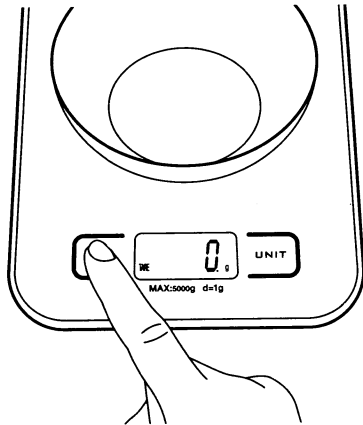



4. Place the desired item(s) to be weighed on the center of the measuring platform or within the tared container to calculate the net weight of the desired item(s).

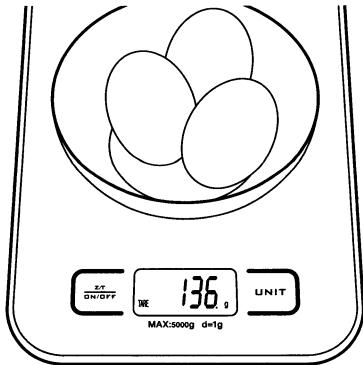

## Unit Conversion

To change the unit of measurement, press the 'UNIT' button until the LCD display indicates the desired unit of measurement.

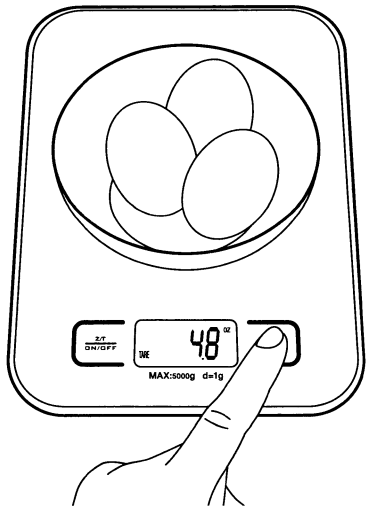

## Automatic Power Off

For battery power conservation, the display backlight will automatically power off after 20 seconds of inactivity. Additionally, the scale itself will automatically power off after 2 minutes of inactivity.

## Manual Power Off

Press and hold the 'ON/OFF' button for 2 seconds to manually turn off the digital scale at any time.

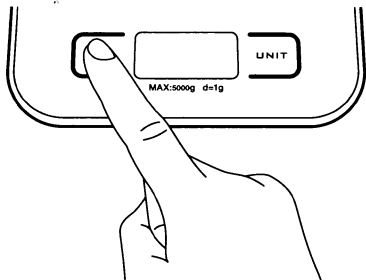

## Battery Replacement

1. Open the battery compartment cover on the backside of the scale.
2. Take out the used batteries and dispose them properly.
3. Install new AAA 1.5 V batteries, taking note of the correct polarity displayed in the battery compartment.
4. Reseal the battery compartment.

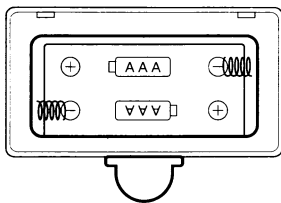



## Specifications

Weight Capacity:	176 oz   5000g   11lbs
Units:	g   ml   oz   lb'oz
Division Value:	0.01oz   1g
Auto-Off:	2 minutes
Power:	2 x AAA 1.5 V DC
Dimensions:	180mm x 140mm x 18mm

## Package Contents

- 1 x Digital Kitchen Scale
- 1 x User Manual
- 2 x AAA 1.5 V DC batteries



## Troubleshooting

### Message

### Reason

### Solution

“EEEE”

Scale overload.  
Maximum weight capacity:  
5,000g (176 oz).

Remove the object from the scale to avoid damage.

“UnSr”

Calibration error.  
Unable to measure weight.

Turn the scale off and turn it back on to retry measurement or auto-tare. Do not move the scale while measuring.



Battery power is low.

Install new batteries.



## Customer Support

Should you encounter any issues or have any questions regarding your new product, feel free to contact our helpful Customer Support Team. Your satisfaction is ours!

Etekcitey Corporation  
1202 N Miller Street, Suite A  
Anaheim, CA 92806

Toll-Free:	(855) 686-3835
Fax:	(657) 202-1693
Local:	(657) 500-1872
Email:	<a href="mailto:support@etekcity.com">support@etekcity.com</a>
Live Chat:	<a href="http://www.etekcity.com">www.etekcity.com</a>

### **Support Hours**

Monday - Friday: 9:00am - 5:00pm PST



# Warranty Information

## Terms & Policy

Etekciti warrants all products to be of the highest quality in material, craftsmanship and service for a minimum of 1 year, effective from the date of purchase. Warranty lengths may vary between product categories. For specific warranty terms, please refer to your product listing page or product operation manual.

Under the limited warranty, Etekciti will replace or refund any parts found to be defective due to manufacturer flaws. This warranty extends only to personal use and does not extend to any product that has been used for commercial use, rental use, or any other use in which the product is not intended for. There are no warranties other than that expressly set forth with each product.

This warranty is non-transferrable. Etekciti is not responsible in any way for any damages, losses or inconveniences caused by equipment failure or by user negligence, abuse, or use noncompliant with the user manual or any additional safety, use, or warnings included in the product packaging and manual.

Etekciti and its subsidiaries assume no liability for damage caused by the use of the product other than for its intended use or as instructed above and within the user manual. Some states do not allow this exclusion or

limitation of incidental or consequential losses so the foregoing disclaimer may not apply to you. This warranty gives you specific legal rights and you may also have other rights which may vary from state to state.

**ALL EXPRESS AND IMPLIED WARRANTIES, INCLUDING THE WARRANTY OF MERCHANTABILITY, ARE LIMITED TO THE PERIOD OF THE LIMITED WARRANTY.**

If your ETEKCITY product should require service: Should your product prove defective within the specified warranty period, please return the defective unit in its original packaging with (1) an original copy of invoice, (2) your order ID number, (3) and your warranty ID number.

## Exceptions & Exclusions

- Damage due to abuse, accident, alteration, misuse, tampering or vandalism.
- Improper or inadequate maintenance.
- Damage in return transit.
- Unsupervised use by children under 18 years of age.

To receive a valid warranty ID number, sign into your Etekcitey customer account at [www.etekcity.com](http://www.etekcity.com). At the top of the warranty page, type in your order ID number located in your order invoice to retrieve your warranty ID number. Your warranty ID number will then be sent to your email for your records. If deemed defective, your product will be repaired, replaced or refunded at no charge to you.

Date of Purchase: \_\_\_\_\_

Place of Purchase: \_\_\_\_\_

Warranty ID: \_\_\_\_\_

Order ID: \_\_\_\_\_

To register your warranty or to make a claim, please contact our helpful customer support team at (855) 686-3835 or email [support@etekcity.com](mailto:support@etekcity.com)

*Please keep this page for your records.*



# ETEKCITY

Building on better living.



Scan here and join the community!  
<http://www.etekcity.com>